

FLEX U BLADDECOREN OP VOORRAAD

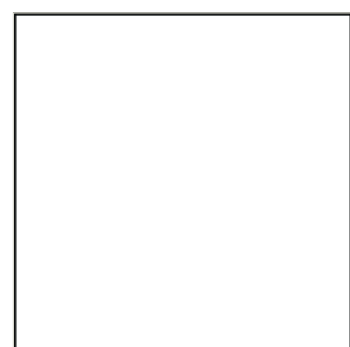

(W) WIT

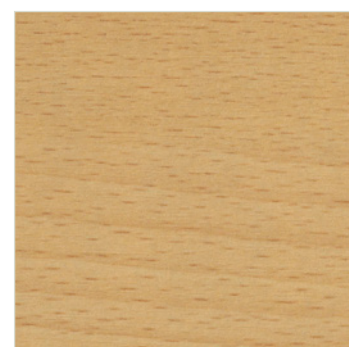

(B) BEUKEN



(H) HAVANNA



(K) KERSEN



(E) ANTRACIET EIKEN



(A) AHORN



(G) LICHT GRIJS



(R) ROBSON EIKEN

BLADDECOREN OP AANVRAAG (LEVERTIJD 4-6 WEKEN)

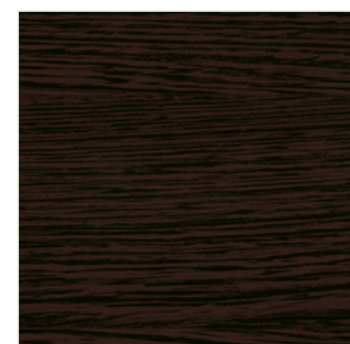

WENGE



NOTEN



ESSEN ZAND

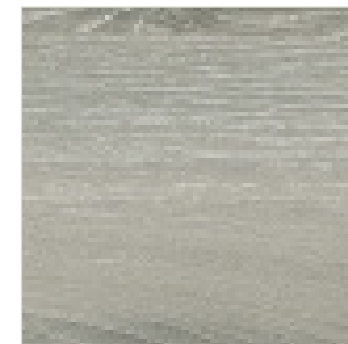

ESSEN GRIJS

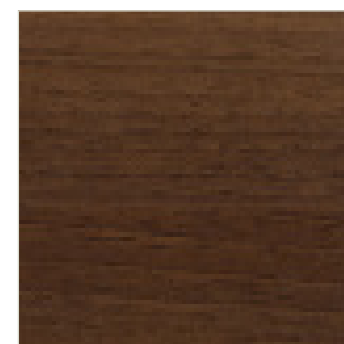

BELLE NOCE



CHATEAU EIKEN



RL EIKEN



HACIENA EIKEN



THERMO PINE



MARRON ESSEN

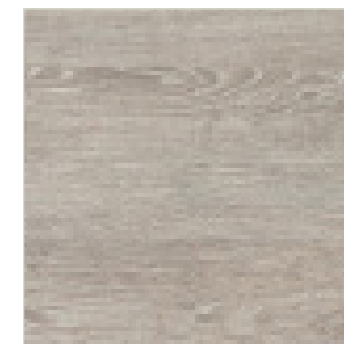

DELANO EIKEN



LOGAN EIKEN

METAAL KLEUREN



WIT (RAL9010)

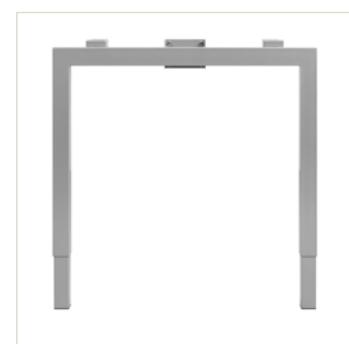

ALUMINIUM (RAL 9006)

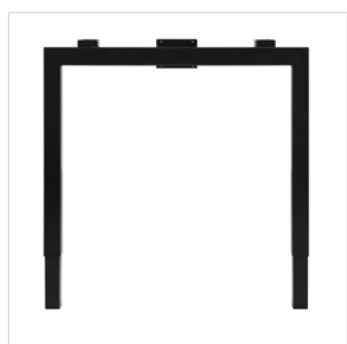

ZWART (RAL 9005)



ANTRACIET (RAL 7016)



SLINGER

AKOESTISCHE SCHEIDINSWAND - AKOESTISCHE VOORZETWAND

Stof: 100% Polyester - 50.000 Martindale

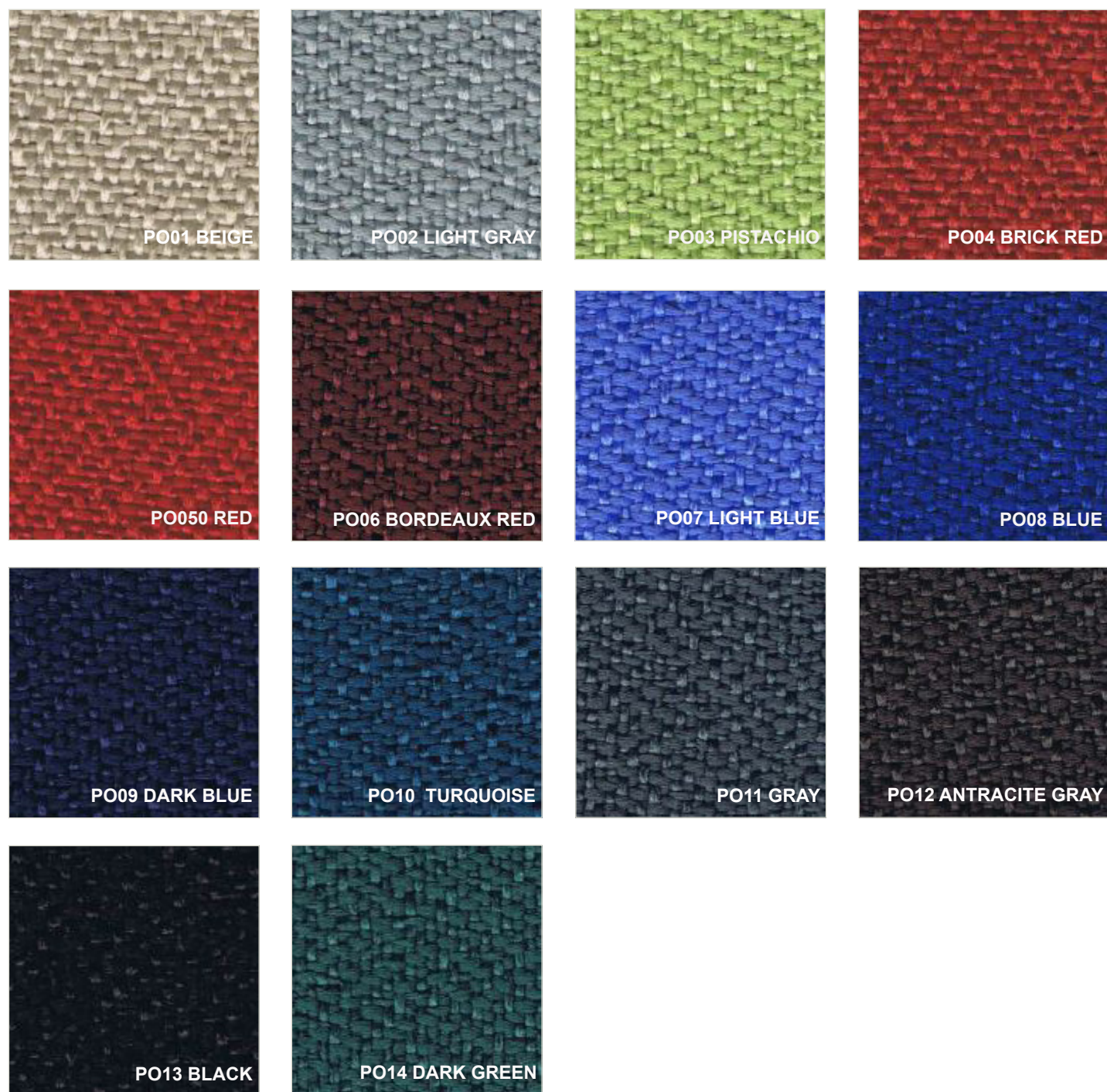

Stof: Wolvilt - 88% Wol, 12% Polyamide - 120.000 Martindale

